



PNNY



***Towards Sustainable
Community Recovery***

PATANKA NEW LIFE PLAN

Patanka Navjivan Yojna



NGOs



SEEDS



26 January, 2003

Project Team

The People of Patanka

EDM (Earthquake Disaster Mitigation Research Center)

Hiroshi Arai, Tetsuo Kubo, Neil Britton, and Hiroyuki Kameda

NCPDP (National Center for People's-Action in Disaster Preparedness)

Rajendra Desai, Rupal Desai, Chandra Bhawsar, Harshad Talapad, Ankit Patel, Pankaj Oza, Harish Patel and Balaji Joshi

NGOs Kobe

Ryuta Suzuki, and Masakiyo Murai

NSET-Nepal (National Society for Earthquake Technology-Nepal)

Shiv Bahadur Pradhanang, Amod Mani Dixit, Bijay Upadhyaya, Ramesh Guragain, Ram Krishna Kasula, Krishna Bahadur Khadka, Ram Lal Kasula, Tulsi Das Kasula, and Prem Lal Kasula

SEEDS (Sustainable Environment and Ecological Development Society)

Anshu Sharma, Manu Gupta, Neena Khanna, Sourabh Gupta, Abhijit Lakhia, Chandra Bhakuni, Kanya Ramchandran, Surya Kakani, Shivangi Chavda, Jai Bhavsar, Rajendra Salvi, Kanayailal Patel, Mushtaq Fakir, Mihir Joshi, Gargi Tewari, Rupali Bajaj, Magan Dharsi, Govind Dharsi, Natalia Kokotos, Stefani Khauser, Ram Krishna, Krishna Bahadur Khadka, Uditya Gohil, Swapnil Joshi, Parth Bhavsar, Rahul Ranade, Dharmendra and Shubrahi

UNCRD (United Nations Centre for Regional Development)

Rajib Shaw, Kenji Okazaki, Yuko Nakagawa, Yuriko Tsunehiro, Kazushi Maki and Masami Kobayashi (Kyoto University)

Project Advisor:

Anand Swarup Arya

Coordinator for Shake Table Testing:

Rajendra Desai (NCPDP)

Coordinators for Rehabilitation of Model Village:

Manu Gupta and Anshu Sharma (SEEDS)

Coordinators for Nepal-Gujarat Mason Exchange and Training Program:

Amod Mani Dixit (NSET-Nepal) and Manu Gupta (SEEDS)

Overall Project Coordinators:

Manu Gupta (SEEDS) and Rajib Shaw (UNCRD)

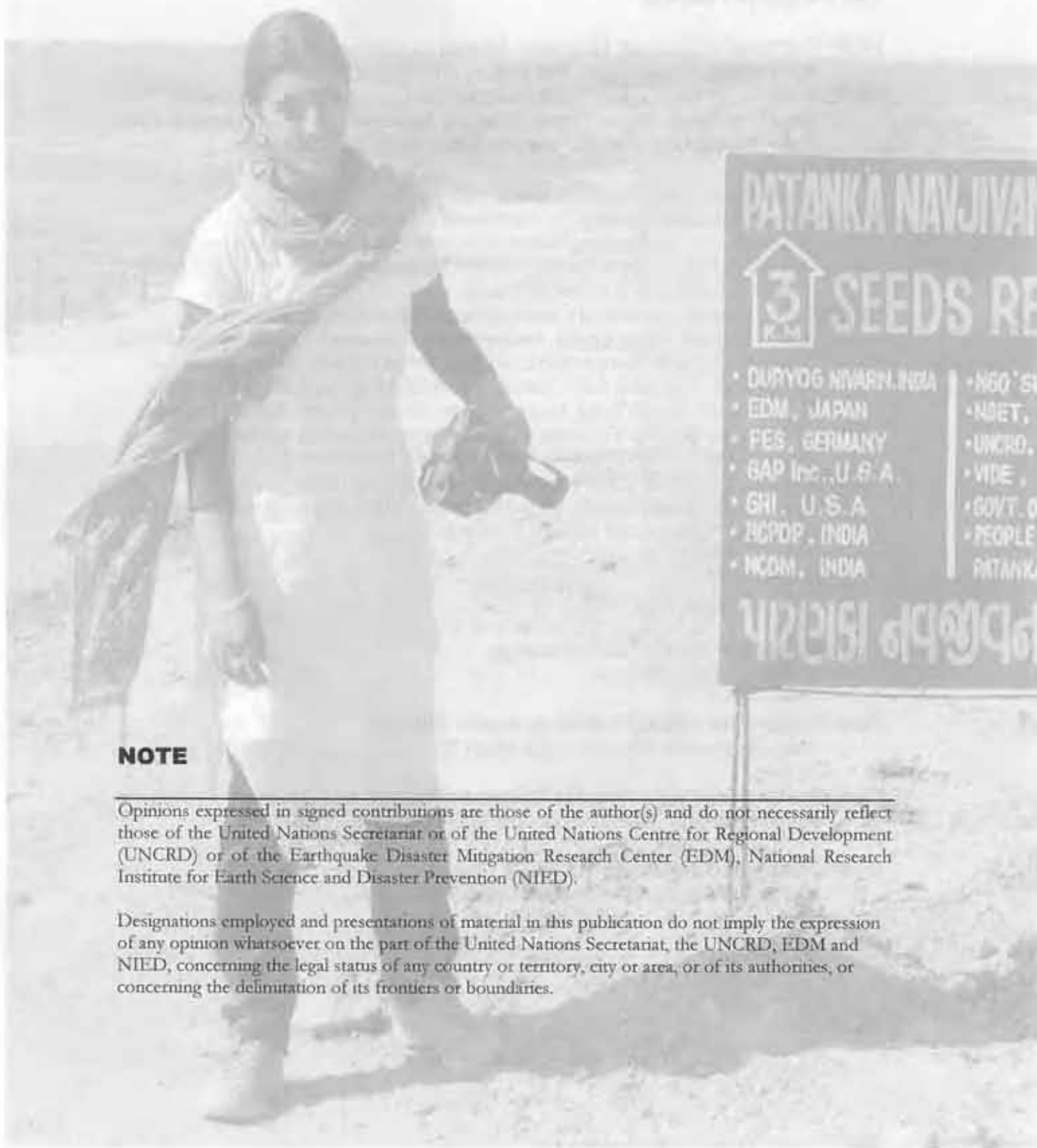

NOTE

Opinions expressed in signed contributions are those of the author(s) and do not necessarily reflect those of the United Nations Secretariat or of the United Nations Centre for Regional Development (UNCRD) or of the Earthquake Disaster Mitigation Research Center (EDM), National Research Institute for Earth Science and Disaster Prevention (NIED).

Designations employed and presentations of material in this publication do not imply the expression of any opinion whatsoever on the part of the United Nations Secretariat, the UNCRD, EDM and NIED, concerning the legal status of any country or territory, city or area, or of its authorities, or concerning the delimitation of its frontiers or boundaries.

Contents

2000
2001
2002
2003
2004
2005
2006
2007
2008
2009
2010
2011
2012
2013
2014
2015
2016
2017
2018
2019
2020
2021
2022
2023
2024
2025
2026
2027
2028
2029
2030
2031
2032
2033
2034
2035
2036
2037
2038
2039
2040
2041
2042
2043
2044
2045
2046
2047
2048
2049
2050
2051
2052
2053
2054
2055
2056
2057
2058
2059
2060
2061
2062
2063
2064
2065
2066
2067
2068
2069
2070
2071
2072
2073
2074
2075
2076
2077
2078
2079
2080
2081
2082
2083
2084
2085
2086
2087
2088
2089
2090
2091
2092
2093
2094
2095
2096
2097
2098
2099
2100



Contents

Acknowledgement	01
Preface	02
1. Introduction	03
2. Issues and Project Methodology	09
3. Activities	13
4. Project Impact	29
5. Future Direction	35
Appendix	39

Acknowledgement

Patanka

The Project Team wishes to express its special thanks to the donors of the project: Gap Inc., Private Citizens from USA, Japan and India, Indian Association of Boston, Clemson and Washington DC., Rotary Club of Bangalore Cantonment, and Friedrich Ebert Stiftung (FES, India). GeoHazards International (GHI) supported the Nepal-Gujarat Mason Exchange Program. Gujarat State Disaster Management Authority (GSDMA) helped in dissemination of PNY experiences to different parts of Gujarat, while National Center for Disaster Management (NCDM) supported its national dissemination. The local governments (district, block and Panchayet) provided support for the adjustments in the rehabilitation packages of the government scheme. The success of the project was attributed to the hard and dedicated work of the people of Patanka for the rehabilitation of their lives and livelihood. The People of Patanka and the Project Team jointly own the project.

© 2004 by the Project Team. All rights reserved. No part of this publication may be reproduced, stored in a retrieval system, or transmitted, in any form or by any means, electronic, mechanical, photocopying, recording, or by any information storage and retrieval system, without the prior written permission of the Project Team.

This document is intended for the community of Patanka. It is not to be used for any other purpose. The Project Team is not responsible for any damage or loss of any kind that may result from the use of this document. The Project Team is not responsible for any error or omission in this document. The Project Team is not responsible for any delay in the delivery of this document. The Project Team is not responsible for any cost of reproduction or distribution of this document.

Preface

Patanka Navjivan Yojna (PNY), meaning Patanka New Life Plan, was a joint endeavor of different organizations of diverse nature from India, Japan and Nepal. The main target of the project was to establish a model of holistic rehabilitation, with incorporation of different elements of livelihood, and involving the local people in the decision-making and implementation process. In addition to the people of Patnaka, project partners included non-government organizations of India, Japan and Nepal, research institute, international organization and government bodies at different levels.

Many useful lessons were learnt during the whole process, starting from gaining of trust of local people, training and confidence building, joint implementation under the government scheme, and incorporation of livelihood programs. The most challenging issue was the exit policy of the Project Team, where the ownership transfer, sustainability of efforts, and dissemination of experiences were key points. Certain schemes were developed to address these issues, and the results in long-term are yet to come.

Over the last one and a half year, many organizations and individuals were involved in the project. Many professionals visited the site, and took part in the training programs in different capacities. It is certainly a challenging task to summarize all these experiences in the form of report. This current report thus provides only a glimpse of all the activities performed in the field. The enclosed CD-ROM provides two video-clips of the village reconstruction and shake table demonstration testing. The detailed activity reports of all the different organizations are also enclosed in the CD-ROM. The photo gallery in the CD-ROM contains the visual images of different activities during the project period.

PNY was a non-ending endeavor, which should be continued in different forms in future. The success of PNY lies in its wider dissemination and usage in its future implementation of sustainable recovery programs. We, the Project Team shall be glad if the readers find this report useful, and our target will be achieved if the readers want to use the methodology in practice.

01

Introduction

- India and its earthquake risk
- The state of Gujarat
and region of Kachchh
- Bhuj Earthquake of January 26, 2001
- Building stocks and its classification



India and its earthquake risk

India is a vast country with an area of 3.29 million sq. km. and a population of more than 1 billion. The country is geographically divided into three parts¹: Himalayan Region, Riverine Region and Coastal Region. The Himalayan region is characterized by a wide variation in topography, geology, soil, climate, flora and fauna, and various ethnic groups with varied socio-cultural traditions, and is a unique geographical entity of the country. The Riverine region is spread across northern, western, and central parts of the country, including the inland parts of the large coastal states. The coastal region has also a large spread (more than 7,500 km long), with increasing numbers of population settling down in the coastal regions.

India is one of the most disaster prone (both natural and man-made) countries for its large number of population. Major disasters include cyclone, drought, earthquake, epidemics and flood. In the decade of 1988-1997, disasters in India affected over 24 million people per year, with an average casualty of 5,116 in each year. In 1998, disasters affected more than 34 million people, with a casualty of 9,846². These statistics show that disaster is a major issue in India, and has a significant impact on the country's development process.

The entire country is divided into five seismic zones, Zone I being the region of lowest seismic activity and Zone V³ being the region with the highest seismic hazard. For obvious reasons associated with tectonic plate boundaries, the north and northeast parts of the country belong to Zone V. A patch of Zone V is also observed in the western part of Gujarat. 12% of the country is located in Zone V, 18% in Zone IV, 26% in Zone III, the rest in Zone I and II. Some major earthquakes of the country before its independence (in 1947) includes: 1819 Kachchh Earthquake (M 8.0), 1833 Bihar Earthquake (M 7.7), 1869 Assam Earthquake (M 7.5), 1897 Shillong Earthquake (M 8.7), 1905 Kangra Earthquake (M 8.0), 1918 Assam Earthquake (M 7.6), 1934 Bihar Earthquake (M 8.3) and 1941 Andaman Earthquake (M 8.1). Most of these earthquakes were confined to the northern part of the country, with mountainous terrain having relatively low population density. Thus, the major effects of these large earthquakes were restricted to changes in the topography, changes in the river courses, without directly affecting human lives.

Increasing population growth, migration from rural to urban areas, unplanned settlements and growth pattern in urban areas, and vulnerable

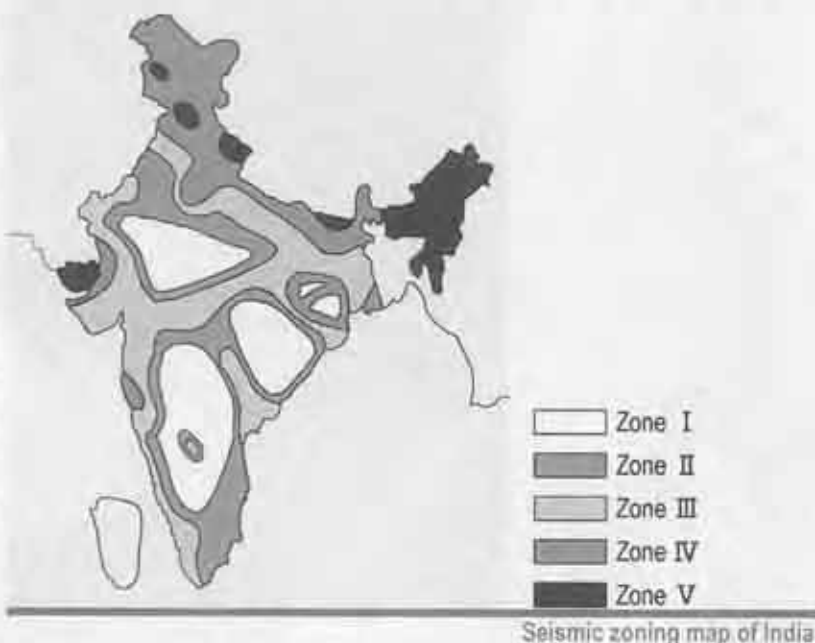

¹ High Powered Committee (HPC) on Disaster Management Report, Government of India, October 2001

² India Disaster Report, Oxford University Press, India, 2000

³ Vulnerability Atlas of India, Government of India, 1997

construction practices have increased the earthquake risk of the country considerably in last the fifty years. This contributed to large numbers of casualties in recent years, even by moderate earthquakes. The 1988 Bihar-Nepal Earthquake (M 6.5), 1991 Uttarkashi Earthquake (M 6.6), 1993 Latur Earthquake (M 6.4), 1997 Jabalpur Earthquake (M 6.0), and 1999 Chamoli Earthquake (M 6.8) are some of examples of this type. Thus, it can be said that India has a moderate earthquake hazard, but high to very high earthquake risk, which is caused by an increase in vulnerability.

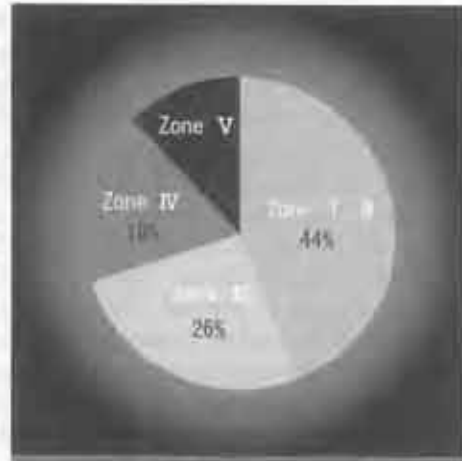

Distribution of seismic zones in India

The state of Gujarat and region of Kachchh

Gujarat is located in the western part of India. Gujarat is one of the most progressive states of India in the field of development and industry. It has an area of 196,000 sq km., however vast areas are not habitable. The state capital is located in Gandhinagar, a twin town of Ahmedabad. The total population is 41 million (1991 census), which is estimated to increase to 47 million in 2000. The rural population is relatively high (66%). The population density is 210 persons per square kilometre but is not uniformly distributed. Kachchh district, for instance, is sparsely populated. The literacy rate is relatively high at 61%, wherein 45% of rural population and 65% of urban population are literate. However, unlike other states, Gujarat has a high net annual domestic product, and high per capita annual income, compared to other states in India.

Kachchh is the largest district of the state and is surrounded by the Rann of Kachchh to its north and east. The Gulf of Kachchh divides Kachchh from the Kathiawar peninsula. Kachchh is separated from the Sindh region of Pakistan by the Great Rann of Kachchh. The salt in the soil makes this low-lying marsh area almost completely barren. Only on scattered 'islands', which rise above the salt level, is there vegetation. During the rainy season, the Rann of Kachchh fills with water isolating the Kachchh region from the rest of the state. Because of this, the people of Kachchh have preserved their local customs and traditions to a much greater degree than elsewhere in the state¹.



Map of Gujarat

¹ The Bhuj Earthquake of January 26, 2001: Consequences & Future Challenges, EDM-IIT Report, April 2001

The Archaeological Survey of India has found Buddhist caves of Emperor Ashoka's time during excavation of Kateshwar. The Chinese world traveller Hue-en-Sang noted around five thousand Buddhist caves in the region. The art, craft and culture of Kachchh flourished under the Gupta Empire; and the Chinese pilgrim mentioned Kachchh as very prosperous under the benevolent administration of Guptas. After the decline of the Gupta empire at around 500 AD, the Maitraka established themselves in Kathiawad with its capital at Vallabhi, presently known as Bhaynagar. During this time, Kachchh was under the rule of Sindh but the Arab raids between 725 AD and 735 AD



Palace in Bhuj

weakened the rule of Harsha and its rule was finally over by internal rebellion. During the subsequent Arab rule, the governor of Iraq sent a force to conquer the Sindh province. They destroyed all trace of Alors authority over Kachchh and gradually conquered Kachchh, Saurashtra and Gujarat. But due to the resistance of the Gurjara and Chalukya rulers of Gujarat, the Arab's had to withdraw. There is no trace that they settled seriously in Kachchh. The Sama Rajput, popularly known as 'Jadeja', came from Sindh and ruled Kachchh from 1510-1948 AD and were one of the longest dynasties to rule anywhere in India.

The long tradition of independence and the relative isolation of this region have resulted in its people's living an independent mode of life. The economy and commerce of this region is not strongly dependent on the rest of the state. The long history of this region has also provided several tourist attractions; and traditional handicrafts and tourism are major sources of revenue and livelihood. The people have also faced extreme hardship at regular intervals, due to occurrences of different types of disasters. Major disasters of the region include cyclones, drought, and earthquakes. Cyclones hit the area at regular intervals, the latest one being in 1999. Water is a perennial problem in the region.

Bhuj Earthquake of January 26, 2001

The earthquake of January 26, 2001 (magnitude 7.7, USGS) devastated the entire state of Gujarat causing extensive loss of life and property. The impact was particularly severe in Kachchh and its neighboring districts of the state. It is estimated that 13,881 lives were lost; besides, over 300,000 buildings were collapsed and more than twice that number were severely damaged. This was a tragic blow to the region that was suffering from a drought condition and the aftermath of two cyclones in last three years.

The damage intensity in the epicentral region has been estimated between MSK Intensity X and XI, signifying that the earthquake was extremely destructive. Around 80% of Kachchh district (the hardest-hit area) belongs to the Seismic Zone V, where earthquakes with MSK intensity IX are expected. About 20% of the district is in Seismic Zone IV, where earthquakes with MSK intensity VIII are expected



Seismic zoning map of Gujarat

(Seismic Code of India, 1984). This region has experienced one of the largest earthquakes to have occurred in India in modern times (magnitude 8.3 in 1819, leading to the death of over 2000 people even though the area was sparsely populated), causing a significant change in the topography. Other major earthquakes in the region include: 1903 (M 6.0), 1940 (M 6.0) and 1956 (M 7.0). Thus, the region is known for its very high earthquake risk and the current earthquake is not an exception.

Historic photo showing the effect of 1819 earthquake



Building stocks and its classification

In India, building stocks are divided into four categories[†]: Category A (buildings made of field stones, un-burnt bricks and clay structures), Category B (mainly brick buildings), Category C (reinforced concrete buildings and well-constructed wooden buildings), and Category X (made up of informal materials like grass, thatch etc.). Out of these, Category A and X can be considered as non-engineered, Category B as 'less-engineered', and Category C as engineered. The most vulnerable types for earthquakes are Category A and B, since the materials are heavy, with stones, mud or brick walls, with reinforced concrete slabs as the roof in some cases.

Rural and urban construction have its characteristic features in India. A typical representative of the rural housing is: 60% of Category A, 35% of Category B, 2% of Category C and 3% of Category X. In contrast, for the urban housing (e.g. in Ahmedabad in Gujarat) the composition is 24% of Category A, 71% of B, 4% of C and 1% of X. For the rural areas, the building materials are mostly local and/or indigenously produced. In most cases, construction is done by the house-owner, and sometimes by local masons. In contrast, for the urban areas, construction is done by a contractor, with mason and helper from different areas, with very little or no involvement of the house owner. The involvement of the house-owner is regarded as a key factor for the non-engineered housing.

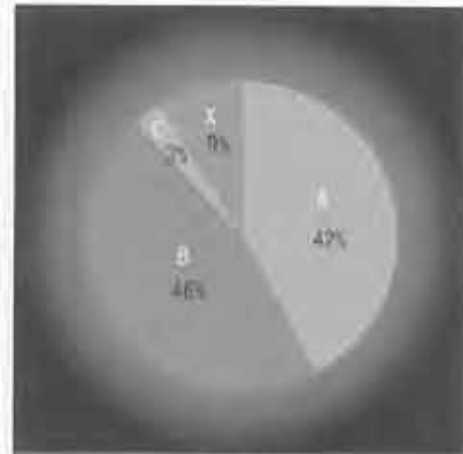

Building stocks of Gujarat

[†] Vulnerability Atlas of India. Government of India, 1997

The building stocks of Gujarat reveal that Category A (stone masonry) and B (brick masonry) have the largest stock, and the state has very little engineered construction. The Bhuj earthquake hit the districts of Kachchh, Jamnagar, Patan, Rajkot, Surendranagar and Ahmedabad severely. The comparison of building stocks in these districts show that, with the exception of Ahmedabad, in most of the districts, the major compositions of buildings are non-engineered. The building stocks of Kachchh district points out the importance of non-engineered construction, and stresses these non-engineered structures use traditional techniques. However due to lack of adequately trained masons, the traditional technology is often not transferred to the local community appropriately. Lack of confidence, low awareness and inadequate training characterise problem of the non-engineered construction.

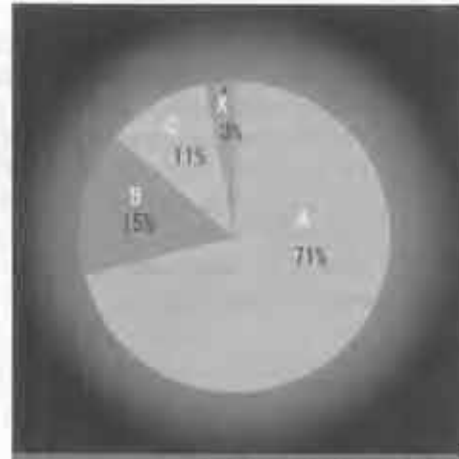

Building stocks of Kachchh district



It now takes 10 months to

get a house built in Kachchh. The reason is the lack of skilled masons and the use of traditional techniques. The government has started a program to train masons and provide them with modern tools and materials. This will help to reduce the time and cost of building a house and improve the quality of construction.

Livelihood in Kachchh



02

Issues and Project Methodology

- Issues of rehabilitation and reconstruction
- Project methodology



Issues of rehabilitation and reconstruction

Several recent earthquakes in different parts of the world have pointed out the importance and need to promote a **culture of safer building practices**. This is specifically relevant in the context of developing countries, where the application of building codes and regulations are often neglected. A specific problem occurs for non-engineered constructions, built by the informal construction sector, without any monitoring and inspection process during construction. The success of seismic safety construction for the non-engineered buildings are often attributed to (1) the **awareness of the house owners and masons**, (2) **training**, (3) **transferring** proper technical skills to the masons, and (4) providing **confidence** to the community for the effective use of technology for non-engineered construction.

Traditional Gujarati housing has two basic attributes, namely, **spatial planning and building system**. Both these aspects at a given point in time are products of evolution over hundreds of years. As a result they both are optimized for the prevailing local context. Spatial planning takes care of the lifestyle of the people that is primarily that of agriculturist. It also helps to conform the life to the local environment. The building system on the other hand protects the house against the elements such as rain, wind, sun and other climatic elements. It has been observed that damages to these buildings are mainly due to **failure of the walls and roofs**. The heavy weight of the roofs causes much damage to the structure. The walls are not jointed properly, and therefore, each wall behaves differently during shaking, resulting in the failure of the structure. Also, sometimes smaller fragments of stones are used to infill the walls, which have usually two bigger stones for inner and outer walls. These smaller stones often fail to

retain cohesion, and the wall thus separates into its component party. Apart from these traditional buildings the damaged structures also include those made of stone with cement mortar, or those made of bricks in mud and cement mortar. All these features point out that the building practices need improvements. One obvious solution is to give training to masons and engineers to make the safer building practices.

The vast **gap between relevant knowledge and practice** is an important aspect in this regard. Regardless of the state of development, it is commonly observed that existing knowledge and technology are not always used. As long as the end-users are not empowered and have confidence in the technology, the process is not sustainable. The process of transferring knowledge into practice is referred to **implementation technology**⁸, which is the process of knowledge, empowerment and sustainability, based on the cooperation of related stakeholders.

Past experiences show that the lessons of the earthquakes are often forgotten. To prevent this, a **culture of disaster reduction** needs to be promoted. This culture can be developed only when local people are involved in the process. The **ownership of both the problem and the solution** lies with the local communities, and disaster reduction initiatives provides certain incentives to the people.

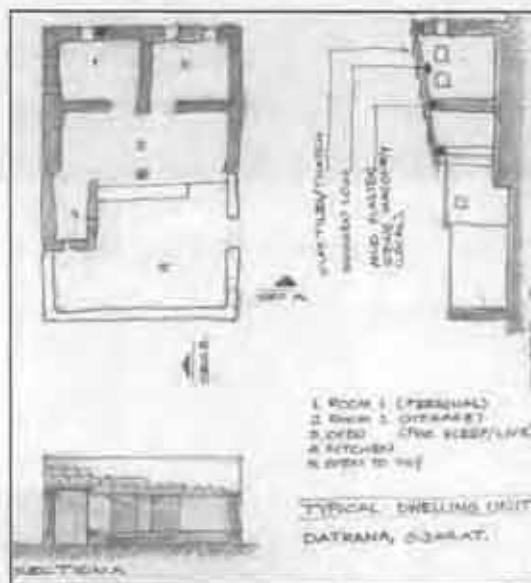

Drawing of a typical rural house

⁸ Kameda (2001): 3rd EQTAR Workshop Proceedings, Manila, The Philippines, EDM Technical Report No. 11, March 2001

This is always a challenging factor. It is often observed that in the rehabilitation period, external agencies, donors and NGOs descend on an impacted area, build the houses and hand over to the people. Thus, the people do not have a direct attachment to the process, and often the technology is not transferred in this approach. The reconstruction efforts are largely ad-hoc, meaning there is no **strategic framework or coordination**. Inadequate planning, coupled with lack of disaster preparedness and mitigation infrastructure, poor information dissemination and inappropriate measures for accountability aggravate the problem. As population increase has been felt in most parts of the world directly contributing to rising trend of life loss, appropriate rehabilitation and mitigation can potentially reduce loss of lives⁷.

The experiences of recent earthquakes in India (Latur, 1993, Jabalpur, 1997, Chamoli, 1999) and elsewhere (Kobe, 1995, Turkey, 1999, and Taiwan, 1999) have shown that the need after the earthquake is to **improve livelihood**, and to enhance the **coping capacity** of the community to provide sustainable development. Past earthquakes in India point out that a program based on the need of the community achieves a great success in long-term sustainability. Thus, it is very important to have a proper perspective of the tradition and culture of the community, and thereby formulating the right program for the right group of people.

Thus, the major problems and challenges targeted in the current initiative include:

- Promotion of culture of safer building practices,
- Bridging the gap between knowledge and practices,
- Preparation of a model rehabilitation program,
- Involving people in the process of rehabilitation, and
- Incorporating livelihood issues in the long-term recovery process.



Damage in rural area

Project methodology

PNY (Patanka Navjivan Yojna: Patanka New Life Plan) was the joint endeavor of a number of organizations in India and Japan. The project was implemented in the village of Patanka, in the district of Patan, the neighboring district of Kachchh. The site was located 180 km northwest of Ahmedabad. There were two major components of the initiative: **one reconstruction and rehabilitation of the model village, and training and confidence building through shake-table demonstration testing**. The characteristic feature of the initiative was to focus on the holistic approach of rehabilitation, where specific focus was given on the improvement of the livelihood. The other aspect of the initiative was to **establish a model of cooperation among different stakeholders** from government, non-government, academics and



Schematic map of Patanka village

⁷ Maskrey (1989). *Disaster Mitigation: A Community Based Approach*, Oxford Publication, 1989

international organizations. The emphasis was to formulate a strategy for effective disaster reduction, which could be applicable to a wider geographical area with different cultural and socio-economic condition. The key point is the **adoptability of safer building practices**, and its application. Through demonstration testing, it is needed to measure the impact on the community is measured and is developed an effective means for confidence building in the community.

The **need for a model approach in community rehabilitation** was felt recently more than ever before. The reasons for these are obvious. Disasters in recent decades were causing more deaths than it did earlier in the century. The worse still, same areas got affected by disasters over and over, and yet the relief and rehabilitation carried out following one disaster did little to protect them against the subsequent ones. In the areas vulnerable to recurrent disasters, the approach of not learning from past experiences, had led to a miserable disaster-poverty cycle. Limited education and awareness among the stakeholders, and lack of confidence in disaster-resistant practices such as construction were regarded as two major reasons for the repetition of the same mistakes and tragedy. Over many years, attempts were being made to develop sustainable disaster management models that can effectively reduce risk. This had been a rather difficult exercise. Experience showed that most 'models' existed as long as there was external support to the local community. The initiative failed soon after external assistance was withdrawn. Ultimately, this resulted in the vulnerability of the community increasing to its previous levels. It was also felt that increased coordination and capacity building among aid agencies, long-term planning and a greater understanding of the recovery and rehabilitation issues could potentially improve post disaster actions at the community level. Thus, the urgency and need for developing a model approach was strongly felt following the earthquake.

PNY was conceived as a **model program right from its inception stage**. It sought to empower the affected community to the extent that they are sufficiently resilient against future disasters. It attempts to link immediate response in the form of relief to mainstream development. Most importantly, it aims to reduce the role of aid agency in local rehabilitation action to a point wherein the local community completely takes over the functions insofar performed by aid agencies.

A further point relates to **Risk Management⁶** and its application in the real world. The shake table demonstration testing and impact analysis was part of 'establishing the context' for effective disaster reduction. A two-step method was envisaged for this: first to study the housing adaptation process, as evidenced from the experiences in the past earthquakes in India. The second step transferred adaptability through the demonstration testing. This process should lead to the development of implementation strategies for effective risk reduction. The risk management process could be exemplified in the framework of the post-disaster scenario with the involvement of different stakeholders, based on the local needs and priorities.



Risk management framework

⁶ Risk Management Standard, AS/NZS 4360: 1999, Joint Australia/New Zealand Standard, SAA Publication, 1999

03

Activities

- Rehabilitation of model village
- Shake table demonstration testing
- Nepal-Gujarat mason exchange program



Rehabilitation of model village

The villages in Gujarat are characterized by traditional caste systems, mainly based on livelihood. Patanka has representatives from six major castes: Ahir (farming), Rabaris (nomadic), Harijans (lower castes in the caste system), Brahmins (worship), and Suthars (carpenters), and Nai (Barbers). However, their occupation has changed over time, and different types of employment such as labor, going out to the town, cutting stones had been popular in recent years. There were 276 households in Patanka, and the population was 1071 prior to the earthquake. Among these houses, 220 houses were completely destroyed, and 45 houses were severely damaged. Education level was relatively low in the village, with almost no literacy in the women.



Damage in Patanka

The process of rehabilitation is based on concerns related to community needs in the aftermath of the disaster, and the need to increase overall capacity to make them independent and resilient to future disasters. Experience shows that in any disaster situation, especially earthquakes, individuals and neighbors are the best disaster managers. Rehabilitation should therefore also be a mitigation exercise⁸. The aim of the PNY initiative is to make holistic rehabilitation with earthquake safe houses, and appropriate livelihood security. The main components of PNY are therefore:

- Rehabilitating lives of the residents of Patanka providing safer houses, better infrastructure and greater livelihood security,
- Shake Table Demonstration for building local capacities in earthquake resistant construction,
- Training, Capacity Building & Monitoring its impact, and
- Formulation of model for future post disaster rehabilitation programs.

Mission

To achieve safe and sustainable livelihood through self-help, cooperation and education

Goal

To build a standard model for disaster resistant community equipped with safer and sustainable livelihood, which well serves its own development needs and serves as a model for others

Objectives

- To make vulnerable communities safer from future disasters
- To strive alongside the community in identifying suitable means of livelihood for making itself independent
- To empower communities so that it is aware of its own needs and is actively able to strive to achieve them
- To establish suitable standards for disaster resistant communities by assisting the community demonstrate its achievements in the post earthquake scenario
- To develop valuable information on implementation technology, and disseminate it globally

⁸ From Disaster to Community Development: The Kobe Experience, UNGRD Publication, 2003

An ideal process in the post disaster scenario needed to link immediate recovery to development. Broadly the process followed three stages. In the first stage, an overall plan defined the principles and the aim of the rehabilitation exercise. The second stage was carried out jointly with the community in

a two-way flow between the Project Team and individual households. The third stage was the exit phase for the Project Team after it ensured sustainability of its interventions while the community prepares itself to integrate itself to mainstream development.

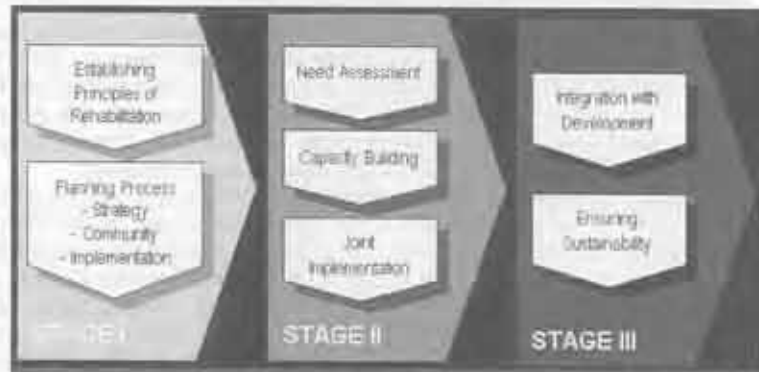

Model used in PNY

The first thing was setting up the basic principles for planning the rehabilitation intervention. The intervention had to be participatory in which the involvement of the community should increase gradually. The program should be flexible with enough buffers for time and resources created in the overall project schedule. Intervention should follow minimum standards on quality of benefits for the community. Rehabilitation was not just a short term gap filling exercise. In most cases, the community faced threat of recurrent disasters and therefore rehabilitation should be aimed at reducing overall vulnerability. This would imply building communities assets, achieving sustainability of livelihood, building houses that could protect against future earthquakes and an infrastructure that potentially improved the quality of life of the community.

The Project Team carried out Relief operations immediately after the earthquake. This was the first interaction with the community. In determining the relief needs of the community during the first visit, a lot of information could be collected about the community's living patterns – their houses, their clothing their habits and customs, food habits etc. This was very helpful in determining future rehabilitation needs.

In case of PNY, the Dialogue, Demonstration and Training was clubbed together in form of a community workshop. The dialogue was structured in which, community leaders, community women were addressed separately highlighting their specific needs. The Dialogue was moderated by a third party (in this case, an NGO with long working experience in the area). Outcome of the workshop was produced as Workshop Resolution. In this case, strong leadership from the village enabled good quality results.

Rehabilitation should be empowering. The Project Team would not, and should not, remain with the community forever. A well-planned rehabilitation exercise could significantly increase the capacity of the community for a more effective response. Social, economic and psychological aspects are integral parts of the rehabilitation program. "Livelihood" could not be ensured only by safer housing and suitable income, but would need to include issues such as welfare, health care, medical service, educational facilities, labor condition, disaster prevention and others maintained in good balance.



Community training

The first community workshop under the PNY helped to understand community needs and preferences. The project team also concluded that existing capacities in earthquake safe construction were very low. The community was ready to build their house themselves however they needed guidance and support in form of building material that was not available locally. The area suffered from recurrent drought conditions, as a result, there was large-scale migration from the community. The rehabilitation Plan needed to include livelihood security issues. The community comprised various ethnic groups. Each had its own style of living. This was to be respected if the rehabilitation exercise was successful.

The Gujarat State Disaster Mitigation Authority (GSDMA), special body constituted in the aftermath of the earthquake and responsible for overall rehabilitation of the affected communities, advised the Project Team to restrict their quantum of assistance to each household to a maximum of USD 200 in kind. GSDMA advised that since, the villagers would be getting their full compensation from the government, any further uncontrolled assistance would create local anomalies in the region.

The area is located in the Zone 5 (the highest hazard area) of Seismic hazard map of India, which indicates that the area is highly prone to possible future earthquakes. The extreme climatic condition and the socio-economic aspects of the area necessitate use of traditional building technologies to build the traditional housing made of stones, adobe and in some cases brick masonries in the rural areas. This had to be accompanied by appropriate awareness, training and capacity building among the local masons, engineers, and house owners. There was thus an urgent need for the integrated training program, where all different stakeholders should act together for the dissemination of technology.

Rehabilitation should also incorporate the local cultural aspects and should try to inculcate safer construction culture to the community. The rehabilitation program should try to establish a strong bond within the community and also within different related stakeholders. The success of the rehabilitation exercise was judged by the degree to which action were replicated by the community, without intervention from the aid agency. Inputs on capacity building were therefore important. Additionally, the Project Team needed to ensure that conditions would continue to exist for easy replication.

The PNY strategy plan was designed, based on past experiences of the team members. Members of the Project Team had studied the 1993, Latur Earthquake (Maharashtra, India) Rehabilitation program in detail. Project Team had rich experience of addressing needs of the people following the 1995 Kobe Earthquake and subsequent disasters in Turkey and Taiwan. For example, it was found that application of safer building practice was the key point of effective Risk Management Process. This, in turn reflects a lack of appropriate risk communication amongst the citizens, local officials, and aid groups. Also, it was observed that in the rural communities, housing was mostly rooted in local culture and tradition, and climatic conditions. Safer Building Practices thus should be well linked to these factors and successful application of the process should have proper understanding among the community.

Incorporating the principles stated above, an overall plan evolved. Such a plan had three parts: **The Strategy Plan, The Community Action Plan and The Implementation Plan.** In the first part, the Project Team based on past experiences and available research drew a broad framework of Rehabilitation - The Mission, Goals and Objectives. This was the Strategy Plan. In the second part, the Project Team actively consulted the community as well as the local government so that implementing strategies were culturally and environmentally compliant, acceptable to the people to whom they were addressed and were within the framework and guidelines laid down by the local government. This was done by organizing local workshops with the community, and involving different stakeholders. In the third part, the Project

Community decision making



Community workshop with women's group

Team devised specific Action Plans for the implementation of various components of the project, these were primarily based on local needs and existing capacities. Development and enhancement of Community Action Plan and Implementation Plan were done in Rehabilitation Stage 2.

Since the role of the Project Team was primarily to facilitate the reconstruction process, the composition of the Team was important. Getting appropriate staff members with suitable motivation and skills was difficult, however suitable training and encouragement could help. Establishing good relationships with the community was the foremost responsibility for the Project Team, skills and knowledge came next. The Project Team had to have an attitude of helping the community so that they can help themselves. Maintaining professional and ethical standards while performing with the community earns respect and trust of the community. The skills of the Project Team in being able to translate their own knowledge into community acceptable practice was a crucial testing point. Besides, the Team would have to ensure transparency in their accounting system and working methods. This helped in establishing credibility for the Team.

This Implementation Stage of the project consisted of three steps: 1) Need Assessment, 2) Capacity Building, and 3) Implementation. In Step 1, focus was given on the following features: 1) Recognizing community's needs, 2) Prioritization of needs as per the available resources, and 3) Translating needs into appropriate action jointly with the community. The role of Government in this stage of the exercise was to provide a recognized legal basis for working in the community. It also reinforced the relationship of the



The old lady making her own house

community with the government. The basic needs of the community were always the same – food, clothing and shelter. Ethnic and regional differences created further complexities in needs. Ground

experiences however revealed that cultural acceptance of external aid is as important as the aid itself. Local needs were determined by interacting with the community- the best way of doing so was through dialogue, demonstration and training. Carrying out relief operations immediately after the earthquake provided a window from which were the community's life styles, habits and customs. This was supported by interactions with the community, especially women. Use of graphic material and practical demonstrations dissolved possible language barriers and increases the scope for community feedback.

In PNY, the local government and the State Government were consulted and kept informed about all developments that were taking place with the community.

A senior official from the local government (the deputy collector of the district) was invited to Patanka. The official and the headman of the village then explained the Local Community Plan to the village.

The Government Official reconfirmed the role of the Project Team and the scope of their involvement in the project. The official also conveyed directly to the community, the government regulations and conditions within which the aid agency had to act.

In order to be successful in carrying out PNY, the Project Team realized (after going through some bitter experiences) that strong leadership at the community level helped.

The Local Community Plan suggested that a house would be gifted to the most needy person of the village. In case of Patanka, this home was for a widow, this was unanimously accepted by the community. In the first month of intervention everything was tested from material to technology to costs, available capacities etc. Making friends with the community during the process of construction helped. By the end of the first 'gift' house, there were 40 Volunteer houses.

Local needs required to be matched with available options to arrive the best fit. Failure to do this might cause problems, as evidenced in the rehabilitation process after the Kobe earthquake of 1995 in Japan (Leckie, 1996). Climatic conditions, cost effectiveness and cultural adaptability were other considerations. Developing options was done through extensive research and analysis. Interacting with the community provided many new ideas. The options developed by the Project Team had to be re-examined in light of the community preferences. The framework of action in the field supported by community preferences defined a Community Action Plan. It had two components: Framework and Process of implementation. The Plan would outline mechanisms through which the actions would be implemented at community level. Also, the mechanism would define action modes and the roles played by different stakeholders. Government guidelines and policies would have to be recognized and interpreted in the local plan.



Reconstruction checklist

Ideally, in a democratic system the government and the community are directly accountable to each other. The role of the Project Team was to strengthen the link between the government and community. Winning the trust of the community was critical for a joint ownership of the process. Unlike program driven development initiatives, a rehabilitation exercise has to be executed in the shortest possible time. Getting full community support in such a short time proved difficult. The Project Team needed to make definite positive moves to win trust. A 'resolution' by the community leaders was sought.

Step 2 aimed for translating plans into action. At the first stage, it was needed to provide training and thereby building capacities in the communities. This was a confidence building exercise through which the local communities gained confidence in the technology and process. Individual householder and family drove the project, and the construction activity was adjusted as per individual's affordability and priorities. Inadequate attention to capacity building could jeopardize any rehabilitation exercise. A wide range of activities were included, ranging from counselling people who had experienced the trauma of a disaster to empowering them so they could well take care of their own needs in case of future disasters. To introduce earthquake safer building technology, local masons needed to be trained. The house owners were influenced to such an extent that they demanded a safer house without compromising on quality of construction.

Training was imparted to local masons and carpenters who were hired by the house owners for reconstruction of the house. The Project Team realized that rather than holding classroom-training sessions for the workers, the best training could be provided in the field itself. Masons who had been trained in earthquake safe construction were brought in and served as master masons supervising the overall construction work in the community. These trained masons were from Nepal and did not know the local Gujarati language. However, the relationship worked very well as they could communicate to their Gujarati counterparts through the language of hands. Within the first 4 months, local masons had picked up skills in earthquake safe construction technologies including the retrofitting of existing houses, and to enhance the understanding of the performance of simple structures with and without the earthquake resisting features under the impact of an earthquake.

Based on the priorities established with 16 communities, an action plan was formulated for reconstructing fully collapsed houses. It was decided that within the ceiling provided by the government, each householder would get USD 200 worth of cement and steel. The labor and basic construction material was to be provided by the household. Household as well as the labor employed by them were trained by the Project Team.

Quality was ensured through regular monitoring of construction activity of each household. Progress was recorded in a specially designed family card. This would also record the material made available to each family as this was done in installments.

Social mobilization toward addressing issues related to personal development and betterment of the community. For activities to be sustainable, strengthening existing democratic structures, compared to creating new ones, would reap positive benefits. Training in leadership is also important. A social calendar of activities ensured a good relationship with the community.

Step 3 focused on joint implementation. Rebuilding homes and lives after a disaster extended beyond mere physical activity on part of the households. As a person rebuilt one's life, he/she would look for an opportunity to get closer to the long cherished dream, while burying the past. The Project Team strived to strengthen those dreams, and not to replace it by their own. The rehabilitation exercise showed best results when the community and the Project Team carried out joint actions. At this stage, along with capacity building, action plans for each area of intervention needed, such as housing reconstruction action plans, house retrofitting action plans, livelihood action plans, and social action plans. To prepare and actualize action plans, one-on-one dialogue with individual household helped. For this Project Team members made themselves available and amenable to all the individual needs and priorities. A previously set ceiling on the expenditure per household with flexibility in design and construction worked well for the community as well as project management. When work sharing was involved, role clarification and transparency were absolutely necessary. These were clarified in Action Plans.



Construction of model house



Family participation in reconstruction

In PNY, the project has been made sustainable by the fact that it focuses in people's knowledge more than physical infrastructures. Capacity building exercises in the project have brought confidence to the house owners on earthquake resistant building technology. Trained local masons have made it possible for them to make their present houses and possible future ones using the same technology.

A pool of trained masons in the community have led to creation of a 'mason's guild' that would now market its own services not just within Patanka but to all other neighbouring villages as well. This is a useful livelihood opportunity in a region where agricultural produce is not enough to sustain households.

With the PNY focusing on building water harvesting structures, there is an effort in improving the quality of life for the residents. The awareness created by transfer of new technologies and their use by the community has created a fresh wave of enthusiasm in the community to better their own lives.

The effort initiated by the Project Team needed to be sustained long after the protect interventions were over. In effect, intervention should be designed to ensure that community would be able to take care of its development needs and become resilient against future disasters. For intervention to be sustainable, capacity building and strengthening/building local institutional mechanisms were necessary. Additionally, local institutions should have adequate capacity and a fixed source of income to be able to exist and carry out its programs. Thus, rehabilitation actions were sustainable if the individual in the community was empowered and owned the project.

Shake table demonstration testing

The overall goal of the shake table demonstration is to provide earthquake safer technology to the people, and to ensure that it is incorporated into practice. The direct objectives are:

1. To build peoples' confidence in earthquake resistant building technologies including retrofitting of existing houses,
2. To enhance the understanding of the performance of simple structures, with and without earthquake resisting features under the impact of an earthquake,
3. To evolve a setup for future improvement and wider dissemination, and
4. To incorporate people into the process of transferring technology through participatory approach by training and capacity building.



Basic Policy: Simple, low-cost and effective

To provide confidence in people for the seismic improvement of houses, Showing the difference between normal construction versus improved construction is one way. A simple shake table and two half-size models were planned. The venue was the Banshali Trust Complex in Radhanpur, Patan district, which was the closest available location near Patanka. The program was designed in close partnership with local engineers and masons. The shake table consisted of a platform, a shock generator, a tractor and two models. The test required of subjecting two structures simultaneously to a series of gradually increasing horizontal shocks and monitoring their comparative performance. Since economic aspects defined the affordability of improved design features and, hence the replicability of each option to be described in the testing, the aspect was also concluded in the study. There was a general feeling among the people that earthquake safety was expensive and, hence, beyond the reach of ordinary people. It was hoped that this view would be altered after villagers saw the tests and understood the wits involved. The cost benefit analysis of retrofitting technology and the seismic elements were therefore carefully performed. The shake table had a simple set-up, but it was equipped with appropriate technical and engineering aspects. The set-up consisted of 6m x 3.6m reinforced concrete platform mounted on two deep girders. Each girder was stiffened by fabricating two bay trusses underside with strut and ties. Each girder in turn was placed on two rollers. The long axis of the platform was the axis of the lateral movement. Four stoppers placed through the

openings in the platform and embedded in the ground restricted the movement to a maximum of 150 mm in the direction parallel to the length of the platform. Rollers consisting of 50mm diameter steel rod were greased to minimize friction and corrosion. The models were anchored to the platform with the help of bars. A tractor, alternating from the long axis end were simulated impart shocks. Shocks are transmitted through a piece of wood projecting in front of the tractor. Rubber padding was installed at the point of impact along the long axis of the platform, and also on the stoppers to minimize damage from the impact.

Technical measurement team



Measurement during shake table test

Selection of test types

Since the program was primarily for confidence building it was necessary prior to deciding the composition of the tests; to determine

- What building technologies the confidence was lacking,
- What new options was confidence lacking,
- What myths, if any, had evolved since the earthquake,
- What were the dangerous new practices had evolved, and
- What were being unduly expensive options used.



Collapse of normal model



Development of cracks in the normal model

Concrete block -improved (left) vs. normal (right) model-



Following were the trends in the post-earthquake scenario:

- (a) After the earthquake the **options not preferred** by villagers were:
Walling – Random Rubble Masonry, Concrete Block Masonry
Roofing – Manglore Pattern Tile Pitched Roof
- (b) The **options preferred** by villagers could be listed as:
Walling – Burnt Brick in Cement Mortar
Roofing – RCC Slab or Manglore Pattern Pitched Roofing
- (c) **Dangerous practices** identified were:
Superficial Repair or damaged buildings
Continued use of vulnerable buildings that lack disaster resistant features
Lack of concern for good construction quality
Lack of concern for the use of disaster resistant features
- (d) **Unduly expensive measures** practiced identified were:
Use of Bricks instead of cheaper options of concrete blocks or random rubble masonry
Dismantling and rebuilding slightly damaged existing building
Excessive use of RCC in conjunction with masonry construction such as column like elements in room corners.

Based on the above circumstances, the decision criteria were as follows:

- (a) Since the reduction in vulnerability of existing buildings was crucial to the safety of millions of inhabitants throughout the region, awareness of the dangers of living in vulnerable buildings and confidence building in the retrofitting of such buildings deserved highest priority.
- (b) Abandoning the random rubble option for walling in favor of burnt bricks would result in more expensive construction and, hence, smaller houses. In addition, some point people would go back to random rubble masonry, since it was the most viable and hence people would have no knowledge of making disaster resistant structures.
- (c) Similarly, favoring of RCC slab in place of Manglore Pattern Tile Pitched houses would result in to more expensive roofing, as well as create houses that were thermally inappropriate. In addition it might create roof that would be difficult to maintain in the long run from the viewpoint of waterproofing.
- (d) Abandoning of cement concrete blocks in areas where bricks were not available would result in more expensive construction. It was important to show that use of concrete blocks with frogs in could make more resistant wall-structure.
- (e) Construction of RCC roof that was inadequately bonded to the walls leading to damage that is difficult to repair. A large-scale use of RCC roof in this manner would result in vulnerable structures. It was, therefore, necessary to demonstrate the result of improved connections between walls and the RCC slab



Stone with cement mortar
-improved (left) vs. normal (right) model-

Test types: focus on local building practices

In the current project, four independent testings were performed using different construction practices. The purpose of each was different, exemplified by the models and the construction materials. For Test 1, two models of un-coursed rubble masonry (UCRM) were used, using mud mortar. Both models were made using traditional methods. Each one was retrofitted using seismic elements like reinforced concrete stitching elements, gable guy anchors, and vertical corner reinforcement. The purpose of the test was to demonstrate earthquake resistant constructions using stone with mud mortar, and to provide confidence in traditional building materials and retrofitting technology.

For Test 2, two models of un-coursed rubble masonry (UCRM) were used, using the cement mortar. One of the models was made using traditional methods, and the other was made using improved seismic elements like through-stones, reinforced concrete seismic bands at different levels, reinforced concrete lintel connection, and corner reinforcement. The purpose of the test was to demonstrate proper earthquake resistant constructions using stone and cement mortar. During this test, neither model collapsed due to relatively heavy construction, and improper joint of the model and the shake table. A new design was made to overcome this problem in the subsequent tests.

Test 3 was the repetition of Test 2. This time the testing went well, and the model with normal construction collapsed, while the model with improved construction had minor cracks, even after several shocks.

For Test 4, two models of concrete blocks were made using cement mortar. One of the models used the conventional method, without frog, and the other used the frog and seismic elements. The purpose of the test was to demonstrate the proper construction methods using concrete blocks.

For Test 1, 2, and 3 the size of the models were 2m X 1.5m X 1.2 m, where the roof was a pitched roof, with clay tiles with timber understructures. For Test 4, size of the models was 2m X 1.5 m X 1.375 m with RC slab as the roof.



Inspection during testing



Damage measurement during testing



Training during testing



Participants of shake table testing

The number of participants of the shake table testing varied from test to test for different reasons. The first test had around 500 people, while the second and third tests had 150 participants. Several reasons are attributed to relatively low participation in the subsequent tests, which include communal violence, and lack of awareness and interest of general public. The fourth test had around 300 people. Participants included masons, engineers, community leaders, women, children, representative of local, state and central governments, and international organizations.

Technical measurement

Resonant vibration testing was performed for the models using micro-tremor measurements. The impacts of the shocks were measured using semi-conductor accelerometers. Accelerometers were placed on the base and the top of each model, and changes in the acceleration were measured. The equivalent intensity was calculated, and an announcement was made to all audience every time in comparison to the Gujarat earthquake intensity. The testing was a part of the training program of the local masons, where masons inspected the damages by themselves, and a full explanation was provided to them for the causes of the damages.



Measurement equipment for shake table testing

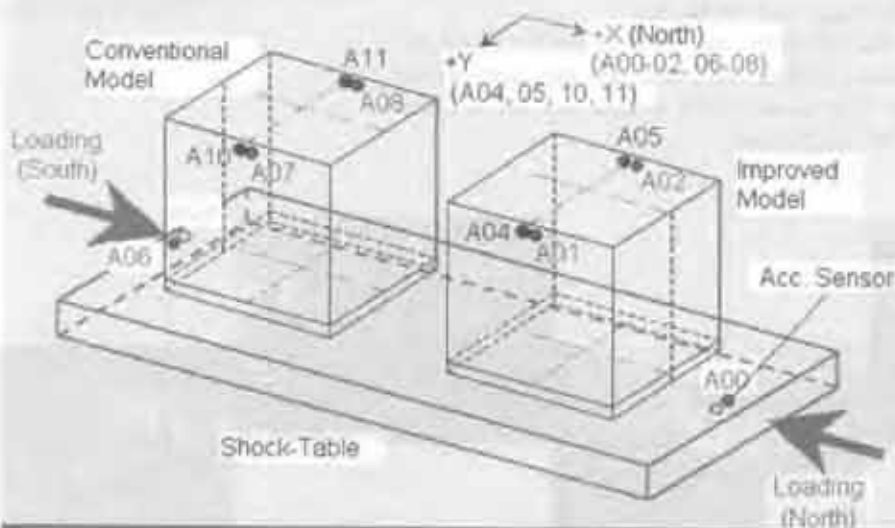

Location of accelerometers in shake table testing

Nepal-Gujarat mason exchange program

To enhance the on-the-job training of masons in Patanka, a mason exchange program was undertaken between Nepal and Gujarat. Nepal has a history of recurring earthquakes, which leads to periodic death and damage. The extent of damage is high because the majority of buildings in the country are built without considering seismic safety requirements. More than 98 % of the buildings in the country are non-engineered. Both in urban and rural areas, traditional craftsmen without any training in seismic safety played pivotal roles.

Seismic safety can be achieved by raising public awareness, transferring ownership of appropriate technology at grassroots level and by involving all stakeholders including the wider community in disaster issues. Since 1998 the National Society for Earthquake Technology (NSET)-Nepal was working toward the institutionalization of a seismic safety culture at grassroots level through some of community-based programs such as the School Earthquake Safety Program.

Masons are key actors in translating designs into reality. Optimum, efficient and effective use of building materials is not possible if masons are unaware about the technology they are working with. There are many ways to train new and practicing masons. The Masons Exchange Program is a new approach in technology transfer. Nepal-Gujarat Mason Exchange and Training Program (NGMETP) was conceived to share the

experiences of trained and experienced masons from NSET-Nepal to fellow masons from Gujarat and vice versa. Exchange visits of Gujarati masons to Nepal and Nepali masons to Gujarat were also expected to fortify the learning process as well as acquire new techniques to make safer buildings.

In general the objective of the program was to start mitigation and preparedness through training and awareness at community level. Specific objectives were:

- Train at least 20 local masons from Patanka in earthquake resistant construction technologies while rehabilitating houses demolished by the earthquake,
- Organize at least three exposure visits of masons from NSET-Nepal and Patanka, and
- Document and disseminate outstanding achievements and explore their replication in communities elsewhere.

To meet the above-mentioned objectives the following strategies were taken

- Use the reconstruction process as an opportunity to institutionalize safer building culture,
- Share experience to the maximum at grassroots level,
- Use of manual methods in construction rather than mechanization in reconstruction works
- Due consideration to serviceability (functional requirements) of building,
- Prime importance to locally available construction materials,
- Reuse of materials in reconstruction,
- Use of local manpower,



Intensity map of Kathmandu valley



Training of masons in Kathmandu

- Technical instruction to craftsmen (local people) in the form of advice with full understanding of reason behind it,
- Conduct an interaction program between engineers and local villagers on mitigation techniques, and
- Mason training program to upgrade local craftsmen's skill in quality construction and develop skillful working manpower in earthquake resistant construction.



Nepali and Gujarati masons jointly constructing model

Activities in the mason exchange program

Situation analysis

Two masons and one engineer from NSET arrived in Patanka on 9th August 2001. The main objective of this visit was to assess the existing rehabilitation process, identify and prioritize existing issues. Planning appropriate interventions and initiating them was some of the main activities planned for the first exchange visit. The Nepali team visited Patanka and the PNY technical personnel to learn about the ongoing reconstruction process. After gaining a clear understanding on the existing issues from observing the NSET- team, a two-pronged plan to improve the ongoing construction activities was devised. The two masons joined their Gujarati counterparts to transfer skills they had acquired in Nepal. The engineer initiated to plan for the interventions with the PNY Team.

Community interaction

The Nepali engineer developed a format to monitor the consumption of materials in the buildings. This worked as a simple and easy tool to monitor as well as assure the quality of construction. The addition of the Nepali team eased the workload on the PNY technical team and allowed them more time to interact with the community. Further, the interaction was made on each issue raised by the community without getting diverted to another topic. This helped to develop a better understanding of the Project Team with the community.

Training workshop by NSET in Patanka



Upgrading skill of masons

The masons seemed to understand all the earthquake resistant construction technologies explained by the engineers in training sessions. The most important component of technology transfer was the proper communication between the trainees and the trainers. This required an analytical approach. Several communication skills acquired through the experience of the Nepali engineer were implemented while the masons were working in the houses. The skilled masons from Nepal were used as a vehicle for technology transfer. The combined effort was effective in upgrading the skill level of the practicing masons in Patanka. This was a short-term and immediate action taken to improve the ongoing construction. A long-term plan on training of masons was conceptualized. The NSET-Nepal engineer and the PNY technical team produced an outline of the training program. Use of three-dimensional models and other relevant audiovisual materials were proposed.

One of the major components was "Kampan Machan" the shake table on which the effectiveness of the seismic resistant components could be demonstrated. It was decided that the masons from Patanka would be trained to construct the models. The engineer then facilitated the PNY Team to fabricate a Kampan Machan in Ahmedabad.



Nepali mason providing on-the-job training

Shake table demonstration by PNY Team

Three masons and one engineer from PNY visited NSET-Nepal and acquired the skill of fabricating the materials required for the model. They constructed one model prototype of Patanka house (1:10 scale) and conducted a demonstration test in front of NSET officials accompanied by journalists of Nepal. The event was widely covered by the daily newspapers including television channels in Nepal. All these events not only imparted the required skill but also motivated them to keep on working on the technology. Back to their workstation they transferred the skill to other fellow workers and the improvement cycle was even more vitalized. The team had upgraded the skill of 60 Gujarati masons including 20 from Patanka with the technical assistance from NSET-Nepal.



Shake table test by PNY and Nepali masons in north India

Upgrading construction quality

Stonecrete block was introduced for the first time in Patanka. Stonecrete block is a masonry component that can replace the stone masonry wall. Stones of irregular shape and size were embedded in lean concrete and compacted into a standard mold. It was cured with clean water for about two weeks. These units were laid in cement mortar to build a wall. Stonecrete block walls are normally used to optimize wall thickness and reduce construction cost without decreasing strength and durability parameters. The same process of making stonecrete blocks can be adopted to cast stonecrete walls eliminating the



process of fabricating stonecrete blocks. One of the Patanka residents preferred the idea of stonecrete wall and used in to construct his building. The stonecrete wall was found to be about 30% cheaper when compared to the prevailing walling system.



Stonecrete blocks

PNY masons getting training in NSET

Training programs

NSET-Nepal developed a module to train new masons as well as skill upgrade the skills of practicing masons. NSET-Nepal provided the PNY Team with a proposed outline of the training program. This outline was jointly developed to make a training manual appropriate to Patanka.

Exchange visit

The first team of Nepali masons worked for a couple of months as it was necessary to streamline ongoing construction activities. The engineer from NSET-Nepal returned after an initial intervention period and organizing logistics to the masons in coordination with PNY technical team. A team of Gujarati masons visited projects undertaken by NSET-Nepal in Kathimandu. An engineer led this team, which included one supervisor and two masons. The main objective was to interact and learn from the experience of various stakeholders involved. To acquire relevant information they visited different school building projects under School Earthquake Safety Project (SESP). This was very useful for the team as they had the opportunity of working in an entirely different situation. The team returned in high spirits, a feeling of dignity and increased self-confidence. This worked as a motivating factor to improve what they were doing in Patanka.

A new team of Nepali Masons replaced those in Patanka. This was done so as to expose a maximum number of masons for mutual benefit. They carried out similar activities as that of the work team. Their main task was to train maximum number of masons and assist in monitoring and supervision of construction.

A team comprising of two engineers from NSET-Nepal visited Patanka during the third week of December 2001. An interaction program with the masons being trained was conducted in Patanka to assess their upgraded skill level. The program revealed that they had developed better understanding. This was reflected in their work.



Model of Patanka house

04

Project Impact

- Rehabilitation of model village
- Shake table demonstration testing
- Nepal-Gujarat mason
exchange program



Rehabilitation of model village

Since the project has several components, the impact should be evaluated in different work with different each target groups. Needless to say, the project had several target groups.

The first target group was at the local level, the community, the masons and local engineers. The impact of the rehabilitation program had two aspects: training and capacity building, and the improvement of livelihood and living condition. A detailed impact analysis was performed on training aspects, and the results are described in the next section. There has been significant upgrading of building conditions, and related infrastructures in Patanka. The residents have a great sense of ownership and pride over the houses and reconstructed infrastructure, primarily because they themselves decided the designs (there were no imposed prototype designs, and each family decided on its house design), they provided most of the material, they paid for the skilled labor, they themselves served as the unskilled labor, and had a central role in all stages of the process. The important aspect was the process, through which the people underwent in the rehabilitation program. All members of respective families were involved in the rehabilitation process, and thus the reconstructed house gave lots of satisfaction to all.



Water is a major issue in Patanka

The socio-cultural attributes of the community were preserved since the village was redeveloped along the same organic pattern and houses were built in similar layouts using the same material as types typical of traditional villages and houses in the region. The settlement did not look like an alien cement concrete city neighborhood, as many other rehabilitated villages in the region do. This feature made the villagers very happy and proud of their project.

The construction process had, as a by-product, created a pool of trained masons out of the villagers. Those farmers whose livelihood were destabilized due to ongoing drought had, through the process of building their own houses, assisting their masons, and participating in the mason training workshops, learnt skills of earthquake resistant construction. In view of the large-scale construction activity that would go on in the region's towns and villages in the coming years, this had created significant employment opportunities for these villagers.

The main elements of success of the project can be contributed to the following factors:

Participation: People from the villages participated and contributed in the rehabilitation program spontaneously, which made the project a holistic one.

Empowerment: The local community was empowered with the knowledge and technology, which was the ultimate goal of the project activities.

Flexibility: The Project Team was flexible to the need and priorities at the local level, which contributed to the smooth running of the project.

Teamwork: The total project is a joint cooperative work of all different organizations and stakeholders. The output could be best viewed with a solid teamwork among different parties, with equal ownership of the stakeholders.

Time-frame: Different activities were planned in specific time frames, and feasibility was initially assessed within the specified period.

Sustainability: The framework of sustainability was formulated in consultation with the community, and thereby a feasible recommendation was evolved.

The second target group was the **policy makers and the decision makers** in central and local government. It was needed to add value to **the strategic decision** made by the policy makers for formulating effective risk reduction process. The Gujarat State Disaster Management Authority (GSDMA), the nodal agency of rehabilitation in the Gujarat Government recognized PNY as 'one of the very few on-going activities in Gujarat, which specifically focuses on community involvement and participation as the core element of project with a clear-cut target to achieve safe and sustainable livelihood'. The National Center for Disaster Management (NCDM) of Government of India commented that 'the participatory approach adopted by the PNY was exemplary, and formed a true national best practice. This kind of work needed to be disseminated at the highest and widest levels possible to upscale it from a model project to a national approach'. This was good recognition from the central government, which proposed to make PNY an example of best practice and a model for future rehabilitation initiatives. The project has evolved dissemination mechanisms at various levels, using appropriate methods. The experiences of the project were documented in video, and presented in different national and international workshops.



District chief of Patan visiting the shake table test

A third target group of this project was the **international community**, including research organizations and international donor agencies. While doing the work at the local level, it was necessary to disseminate information and experiences globally, and make sure that the model of **implementation technology** would be applicable to a wider community in other vulnerable locations of the world. The United Nations International Strategy for Disaster Reduction (ISDR) recognized the PNY as a successful case studies, and incorporated in its World Disaster Report. Also, regional disaster centers such as Asian Disaster Preparedness Center (ADPC) recognized the mason exchange program as a successful south-south cooperation on community based disaster mitigation.

Shake table demonstration testing

An assessment of the effects of the shake table demonstration needed close monitoring of participants to understand specific aspects of the effects. This was done through a survey conducted questionnaire. In fact, there were two questionnaires, one is before and another is after the demonstration testing. Pre-test questionnaires tried to understand the general perspective of masons about seismic safety, while post-test questionnaires aimed to understand the impact of testing.

General observations on the background of the masons were as follows:

- 28% of the masons were from urban areas, while 78% were from rural areas,
- Average age was 32 years, with a variation from 19 to 50 years,
- Approximately half of the masons completed primary education, while 20% of them did not go to school at all,
- 84% of the masons were main earning members of the family,
- 67% of the masons had an annual income of 240-720 \$, 21% had an annual income of 720 \$, and 12% had an annual income of more than 240 \$,
- Average employment days for masons are 160 per year. However, 44% has employment for more than 180 days per year, 36% between 120-180 days, and 20% less than 120 day per year,

- 72% of the masons were engaged in other activities, apart from mason work (42% in agriculture, 46% as labor, 14% in miscellaneous activities).
- The majority (65%) of masons started their work in the age group 15-20 years, and 30% started their work between 20-30 years, and
- 88% of masons were trained by fellow masons during their work, 12% accepted this as family professions.

Regarding the types of work, the following information was collected:

- 58% of the masons were engaged in masonry work (brick, stone, concrete blocks), 27% is specialized in brick masonry, and 5% in stone masonry, and
- 80% masons preferred brick and cement as the building materials, and tiles as roof materials. Stone as a building materials had a low preference.

Thus, it can be said that there was a high preference of cement-based building materials, and most of the masons referred to building materials as the prime cause of damages due to earthquake. This was relevant to the first and second tests, where the aim was to build confidence for stone and rubble masonry with both mud and cement mortar.

In **Test 1**, 105 completed pre-test forms were selected after scrutiny, and 85 post-test questionnaires were analyzed. Although statistical figures should not be used as a yardstick to measure qualitative characteristics such as confidence building, type of learning experience, however through the questionnaire survey an attempt was made to understand the overall impact. Some of the major observations after **Test 1** are:

- 25% masons came to learn new lessons, 62% come with the idea of "worth seeing". Hence, for most of these people it was a learning experience, and confidence building and also suggested to demonstrate the test in other parts of Gujarat,
- The show was a confidence building in earthquake technology to 42%, gave a new lesson to 25%, learning experiences to 18%, and need for dissemination for 10%.
- Before the test, 78% had faith in retrofitting, and 22% was not sure, which changed to a unanimous agreement that retrofitting was a useful and necessary tool,

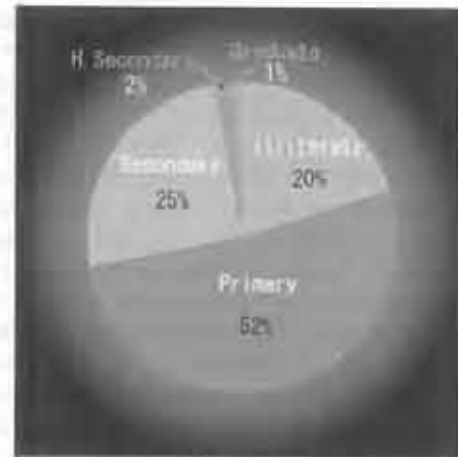

Educational background of masons

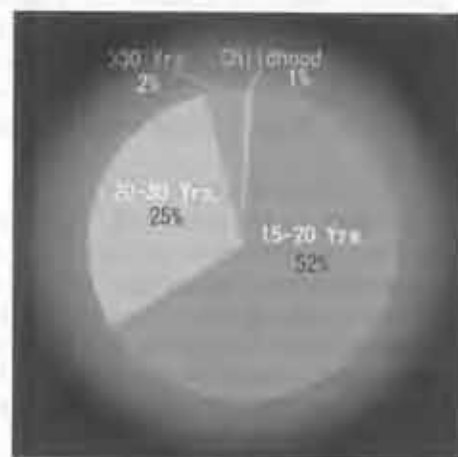

Age showing start of mason work

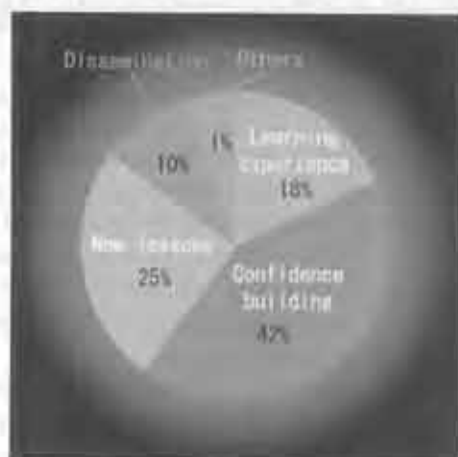

Impression of masons after the Test 1

- 57% of the masons were convinced that retrofitting was cheaper than new construction, 36% thought that it would be costlier, and 7% did not answer. Thus the majority believed in the cost-effectiveness of retrofitting, and
- Among the retrofitting elements¹⁰, 42% of masons had confidence in headers and vertical reinforcement, 27% had confidence in the previous two elements plus bracings and gable strengthening, and the rest was a combination of different elements.

There was no post-test analysis after **Test 2**. In **Test 3**, 27 completed questionnaires were collected and analysed. The reason for a relatively low number of questionnaires was attributed to the volatile situation at the aftermath of communal violence in Gujarat. The major observations were as follows:

- 65% of the masons told that it was worth seeing, and learning experiences,
- 65% answered that their confidence increased in seeing the test, while 35% answered that there was no change,
- 45% had confidence in header, vertical reinforcement and gable strengthening, while 35% had confidence in above the three elements plus the band, and the rest opted for a combination,
- More than 65% of masons remarked that gable strengthening, header and vertical reinforcements are relatively easier and convenient, while seismic band seemed to be more difficult, and
- 60% of masons wanted to see the shake table test for concrete blocks and brick in cement mortar.

In **Test 4**, 72 forms were collected and analysed. Major observations were as follows:

- The test was a confidence building in earthquake resistant construction technology to 78% masons. 96% of masons believed that earthquake resistant practices should be followed in Gujarat,
- Only 20% of masons followed the new technology, while 80% used conventional methods,
- Most of the masons wanted the test is shown in the other parts of Gujarat,
- Masons were asked about the best way of dissemination of technology. The answer was: 10% for mason's training, 25% for information to the house owners, 8% for government training, and rest suggested the combination of all different process. 73% felt that house owners should be informed, 48% believed in mason training and 36% felt government training as important ways of dissemination,
- Among different seismic elements, 80% masons believed in reinforced concrete band, 85% believed in vertical reinforcement, and 59% believed in a combination of different elements for concrete blocks buildings,
- As for the causes of damages: 31% believed it was caused primarily by materials, 24% in quality, 9% in age, and 36% in the construction types, and
- 28% masons stated that additional cost for earthquake resistant features would be 10% of total construction cost, 70% told that it would be 20% of the total cost, and 2% suggested it would be more than 50% of the total cost.



Suggested ways of dissemination of shake table experience (M: mason, HO: house owner, GO: government)

¹⁰ Retrofitting elements included headers, vertical reinforcement, in-place bracing, gable strengthening and seismic band.

Factors affecting impact analysis

At the onset of the series of testing, the NGOs actively participated in the first test by bringing masons from their respective villages. It was hoped that it would continue in the next tests. This was desirable since the masons would pass through all critical aspects of technology transfer that was intended. If the same set of masons participated in all the successive tests, the continuity would have been maintained in interaction with them. It would also be possible to correlate the responses from each test since the "background" data would remain unchanged.

But this did not happen. Although, the same NGOs did participate in more than one test, it was difficult for them to bring the same masons. Many of them preferred to bring different masons from different villages so that their target villages were treated evenly, and different masons shared the experiences.

The communal violence of Gujarat strongly affected the test, and Test 3 was practically kept in the close circle. Also, time factors affected the interest of masons and NGOs. Most of the construction work was completed within the first year of the earthquake, and many NGOs did not feel the need to show the testing to their masons. One-day work compensation was also another factor for decreasing number of participating masons.

Nepal-Gujarat mason exchange program

It was quite difficult to define precise indicators for the impact assessment during the inception stage, and the whole program was visualized as an experiment. Nevertheless, this experiment with this new approach worked out to be one of the more effective ways to technology transfer. The ever increasing and encouraging positive impact on PNY is one of the major factors of continuing NGMETP in the second phase. At this level the positive impact of NGMETP can be clearly observed at three major levels: One of them was in the community level, the other was in the attitude of the trained masons and the most important aspect was construction quality and safety level of the buildings.

The community members had acquired a better understanding and faith on the construction technology. They started accepting the fact that quality in construction process was more important than having a thicker wall. The wall thickness in many cases was reduced from 45 cm to 35 cm, with stone masonry in cement mortar. This reduced overall rehabilitation costs. This acceptance on the technology and availability of skilled human resources resulted in better sustainability of the technology.

A brand name has been developed in the name of Patanka masons, and this brand got popular among the surrounding villages. This not only widened the employment opportunities, but also helped gain confidence and pride in the work of the trained masons. This helped them to understand the actual importance of the appropriate technology.

Most importantly the construction quality, strength and durability including the safety level of the buildings were highly improved. It is true that even without NGMETP the masons would have incorporated the seismic resistant components in the reconstructed buildings. It has been observed that the damage ratio of these buildings would be reduced from an existing more than 100% to about 35%. In this case the resources spent on this part would not be as beneficial and effective as it has been possible with NGMEP. Certainly it would be unrealistic to claim that the damage ratio was achieved to an absolute zero level, but in case the same intensity earthquake repeating in Patanka, damages might be reduced to a single digit, which was a great achievement.

05

Future Direction

- Sustainability of PNY efforts
- Dissemination of PNY experiences



There are two major challenges of PNY in the near future: Sustainability of PNY efforts and Dissemination of PNY experiences.

Sustainability of PNY efforts

The effort initiated by the Project Team needs to be sustainable long after the interventions are over and the Team is withdrawn. In effect, intervention should be designed from the beginning to ensure the community is able to take care of its development needs and was resilient for future disasters. For intervention to be sustainable, capacity building and strengthening/building **local institutional mechanisms** were obviously needed. Additionally, local institutions should have adequate capacity and a fixed source of income to be able to exist and carry out programs. Rehabilitation actions can be sustainable if the **individual** in the community is empowered and owned the project. The individual should be aware of his rights and know the way to take action on them.

Based on this basic philosophy, the Project Team focused on the people's knowledge more than on physical rehabilitation. A pool of trained masons in the community led to the creation of a "mason's guild" that would market its own services not just within Patanka but also to all other neighboring villages. This was regarded as a useful livelihood opportunity in a region where agricultural products are not enough to sustain households.

To ensure the institutionalization of the efforts in the trained masons, **Patanka Reconstruction Private Limited** was proposed as a construction company, promoted by SEEDS, the main implementing partner of the PNY project. The farmers whose livelihood was destabilized due to successive years of drought were trained as skilled masons, and are now capable enough of taking up construction work as an alternative means of livelihood. To help them get into an organized structure, the idea of initiating a Construction Company came into existence.

Thus, it was felt that the proposed name of the Company should have the name of the village from where it had its roots. The company proposed to take up retrofitting,

rehabilitation and disaster resistant construction, which were its unique selling point. It was deliberately named as a Reconstruction Company instead of a Construction Company. "Patanka" as a brand name stood for good quality disaster resistant construction using appropriate technology and promoting local resources. Also, in order to promote social development, the company would like to commit 20% of its profits for this cause: 5% each for Research and Development, development of Patanka and local initiatives, capacity building activities, and Community Risk Reduction Fund (CRRF).



Poster for new construction.



Poster for retrofitting.

The company would be developed in three phases: **inception phase (2002-2004)**, **establishment phase (2004-2007)**, and **expansion phase (2007-onward)**. In the **inception phase**, SEEDS would act as the sole promoter of the company, responsible for the institutionalization and training for the company. This phase would be the most crucial, on which the future of the company would depend. In this phase, the foundations would be built in core strength areas i.e. construction of disaster resistant buildings and retrofitting activities. In the **establishment phase**, the company would have been in existence for two years, therefore the focus would be on strengthening its hold in the market. The company would enter into strategic partnerships, which would determine the work area and type of funding. The **expansion phase** would include providing a new direction to the company by making itself sufficient and self-accountable. There would be a lot of reorganization in roles and responsibilities. The main aim of establishing this company was that the masons could use their construction skills as the means of their livelihood. So during this stage, the company would start looking beyond the initial promoter SEEDS.



A temple affected in 1905 earthquake

Dissemination of PNY experiences

Dissemination of PNY experiences is an important aspect of the project. The dissemination should be within the state, in the country and outside the country. To disseminate the experiences within the state of Gujarat, different schemes of cooperation have been formulated: cooperation with NGOs working in the Kachchh area for the mason exchange program, new project with GSDMA for sharing the experiences with other parts of Kachchh, proposed training programs in the disaster management resource centers in Gandhidham. All these could be made feasible through constant lobbying, and networking. The PNY video (shake table testing) was broadcasted on state-wise television, and was used as a training kit for different parts of Gujarat.



Map showing Parvat Yatra areas

The most important dissemination of PNY experiences was in the light of mitigation and preparedness efforts for future earthquakes in northern parts of India. A comprehensive program was conceptualized and implemented by SEEDS, in cooperation with national government (NCDM), NGOs-Kobe and UNCRD. The program was termed as 'Parvat Yatra' (A journey to the mountain), in response to the International Mountain Year of 2002. It was planned to cover the northern part of India.

The northern part of India had high to very high seismic risk, and was in Seismic Zones V and IV (two most high hazard zones). The risk in the hill areas was of higher magnitude since the tectonic movement in the Himalayan region was more pronounced than in Gujarat, and the area was known to have a return period of eight years for major earthquakes. Districts of Bageshwar, Chamoli, Pithoragarh and Uttarkashi experienced major earthquakes in recent times. The very area is now home to a number of densely populated urban centers, unmindful of the seismic risk. The risks were further accentuated by the fact that most houses in the area were built of heavy stones, had poor binding material, and incorporated no earthquake resistant features. Striking similarities with the construction materials of the Patanka houses helped the masons to train their fellow masons in northern India.

Three community training workshops and shake table demonstration were completed: one in Bageswor, Uttaranchal (July 22-23, 2002), second one in Jawlamukhi, Himachal Pradesh (October 26-27, 2002) and the third one in Assam (December 15-17, 2002). The community workshops included a shake table test, an exhibition, and a poster

campaign towards raising awareness of the community. These were presentations by local NGOs active in the region and government representatives.

The workshops had an average of 150 participants and reached out to a large and varied audience with participation from Panchayat (local government) representatives, Mahila Mandal (women's groups) representatives, city/ municipality/ district administration, local masons, school teachers, college students, NGOs and local Community-Based Organizations (CBOs).



PNY team with students



PNY masons making model in north India



PNY masons performing shake table test in north India



Participants of shake table test in north India

A promising start has been made, and it is hoped that the high spirit of PNY will be continued in local, national and international level. PNY has the potential to be the model approach for a successful disaster reduction activity in the community level.

Appendix

1. Press coverage
2. Comments
3. PNY partners
4. Contents of CD-ROM

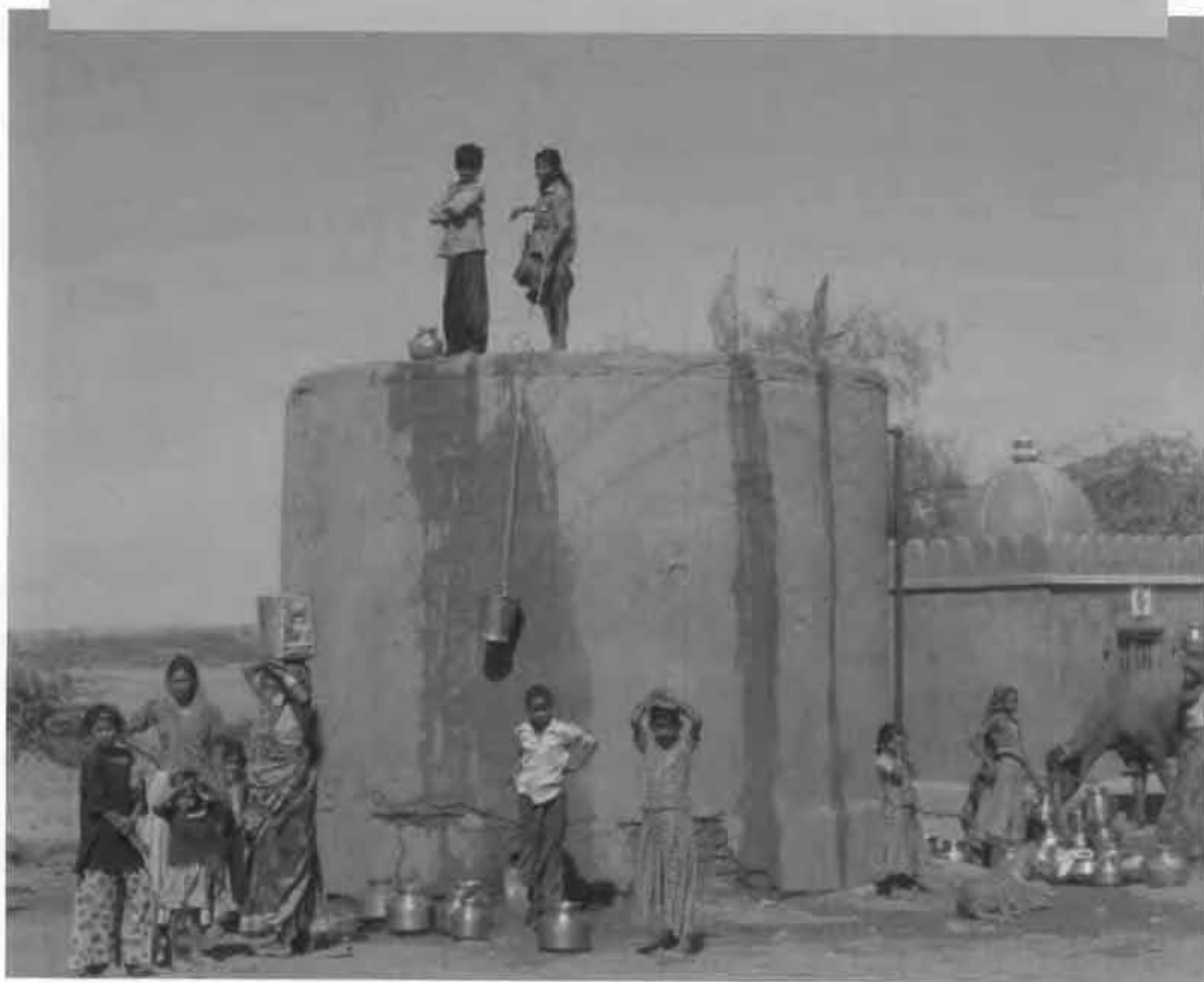

...the ... of ...

...the ... of ...



...the ... of ...

- 7. ...
8. ...
9. ...
10. ...

Living with Risk (ISDR, July 2002)

Economic Times (November 17, 2002)

GSDMA Newsletter (PlainTruth, August 2002)

Apparel Online (December 1-15, 2002)

ADPC Newsletter (December 12, 2002)

Peace Winds Japan Newsletter (April 2001)

Missions from Nepal Help a Community of Gujarat Rebuild their Lives

In the aftermath of the Gujarat earthquake...

A disaster relief mission...

Peace Winds Japan...

...the ... of ...

...the ... of ...

...the ... of ...

...the ... of ...

...the ... of ...

...the ... of ...

...the ... of ...

...the ... of ...

...the ... of ...

...the ... of ...

...the ... of ...

...the ... of ...

...the ... of ...

...the ... of ...

...the ... of ...

...the ... of ...

...the ... of ...

...the ... of ...

...the ... of ...

...the ... of ...

...the ... of ...

Online

TrailWatch

in Boulder, Site of 1/2 Lead Contam

...the ... of ...

Money from the Market

...the ... of ...

Building Goals for Water Collection

...the ... of ...

and Other Trade Tips

...the ... of ...

and Jobs from the Market

...the ... of ...

Original Responsibility

Human face of Apparel

...the ... of ...

...the ... of ...

...the ... of ...

...the ... of ...

...the ... of ...

...the ... of ...

...the ... of ...

...the ... of ...

...the ... of ...

...the ... of ...

...the ... of ...

...the ... of ...

...the ... of ...

...the ... of ...

...the ... of ...

...the ... of ...

...the ... of ...

...the ... of ...

...the ... of ...

...the ... of ...

インドから届いた SOS

...the ... of ...

...the ... of ...

...the ... of ...

...the ... of ...

...the ... of ...

...the ... of ...

...the ... of ...

...the ... of ...

...the ... of ...

...the ... of ...

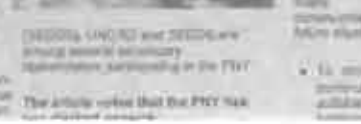
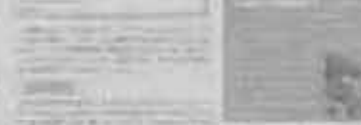
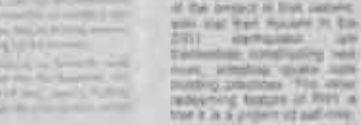
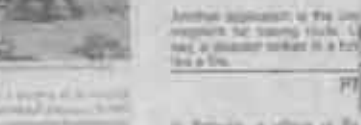
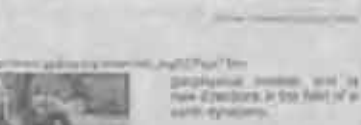
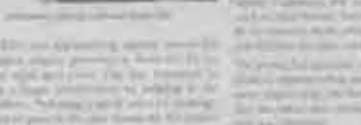
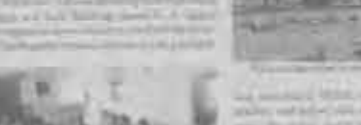

...the ... of ...

...the ... of ...

...the ... of ...

SEEDS approach is to enable in action. It believes that the role of external support is that of helping people rebuild their lives, based on mutual respect and true partnership. The approach they have adopted needs to be learned by other organizations.

David Sanderson, Technical & Policy Adviser, CARE International, UK

The approach involves people, gives ownership of the problem and solutions to the community, builds confidence in the technology, uses traditional designs and materials, and trains people to engage in wider dissemination effort. The use of Nepali masons as trainers will benefit construction practices in Nepal as well when masons return home with even greater understanding of their craft and the reasons for the practices they espouse. This is important to apply this methodology to other parts of the world in different rehabilitation.

Tom Tobin, Adviser, Federal Emergency Management Agency (FEMA), USA.

There are a number of key elements in PNY: the project is need-based, adopt the broad development principles, and is process oriented. Instead of providing just infrastructures, the project focuses on the building capacities within the communities.

Ian Davis, Cranfield University, UK

The participatory approach adopted by the PNY is exemplary, and forms a true national best practice. This kind of work needs to be disseminated at the highest and widest levels possible to upscale it from a model project to a national approach.

Vinod K. Sharma, Professor, National Center for Disaster Management, Government of India

In the PNY project, the holistic approach has been adopted, with a view to evolving a model, which can be replicable anywhere else in the world. PNY is one of the few on-going activities in Gujarat, which specifically focuses on the community involvement and participation as the core element of the project with a clear cut target to achieve safe and sustainable livelihood.

V. Thiruppugazh, Joint CEO, GSDMA, Gujarat

While in some places, aid agencies had built and handed over houses to villagers, the experience of a local community in Patanka shows how community led rehabilitation can yield results.

World Disaster Report, ISDR Secretariat, Geneva

SEEDS is working to ensure that our houses can resist the next earthquake

Rama Bahura, House Owner, Patanka

Rama, Krishna and Vijay from Nepal did a lot of work here. I learnt a lot from them.

Anjan Tarshi, Mason, Patanka

About the shake table testing:

Engineer will not make a mistake if they see this: Junior Engineer

People will get confidence that with a little extra cost, their houses can be earthquake safe: Engineer

House owners must know this technology: NGO Representative

The one retrofitted will not collapse. It is true. We saw it: Mason

Earthquake Disaster Mitigation Research Center (EDM) is a research organization under the National research Institute for Earth Sciences and Disaster Prevention (NIED), and is located in Hyogo in Japan. The center focuses on interdisciplinary applied research with direct link to implementation process. The center has developed a number of tools for risk mitigation measures since its inception in 1998, and is engaged several projects in different parts of the world. In the PNY project, the EDM was mainly involved in the shake table demonstration testing and its impact assessment.

National Center for People's-Action in Disaster Preparedness (NCPDP) is a non-government organization, located in Ahmedabad, Gujarat, India. The organization has been actively involved in dissemination of earthquake resistant non-engineered construction practices in different parts of India. After the Gujarat earthquake, NCPDP was involved in training of masons in more than 450 affected villages all over Gujarat. In the PNY project, NCPDP was involved in the implementation of shake table demonstration testing.

NGOs Kobe is a non-government organization, located in Kobe, Japan. After the Great Hanshin-Awaji Earthquake of 1995, the organization started coordination work for disaster recovery in different parts of the world. The main goal was to disseminate the experience of the great Hanshin Awaji Earthquake. In the PNY project, NGOs Kobe was involved in the village reconstruction with special emphasis on livelihood recovery.

National Society for Earthquake Technology (NSET)-Nepal is a non-government organization, located in Kathmandu, Nepal. From 1998, NSET-Nepal has been involved in earthquake awareness raising program in Kathmandu valley in Nepal. Through its unique School Earthquake Safety Program, NSET-Nepal has provided training of masons on earthquake resistant non-engineered construction practices. In the PNY project, the NSET-Nepal was involved in OJT (On-the-Job Training) of masons, and mason exchange between Kathmandu and Gujarat.

Sustainable Environment and Ecological Development Society (SEEDS) is a non-government organization, based in Delhi, India with branch offices in Gujarat, including Ahmedabad and Patan district. The mandate of SEEDS is research, development and field implementation of community based disaster mitigation projects and programs. SEEDS has been involved in different parts of India in mitigation and recovery projects, as well as policy development in the national level. In the PNY project, SEEDS was the coordinator for the implementation of the village reconstruction part, from the village selection to house reconstruction, and livelihood programs.

United Nations Centre for Regional Development (UNCRD) is a UN project office, located in Kobe, Japan. The headquarter of the UNCRD is in Nagoya, Japan, and the Disaster Unit has been established its new office in Kobe in 1999, after the Great Hanshin Awaji Earthquake. The mandate of the office is training and research, and dissemination of best practices on disaster management globally. The center has been involved in disaster management projects in different parts of the world. In PNY, UNCRD was involved in training and shake table demonstration testing, and overall coordination in international level.

1. Document

- 1.1 Research Plan PNY Project
- 1.2 Methodology for PNY Project
- 1.3 Rising from the Rubble
- 1.4 Shake Table Design
- 1.5 Shock Measurement
- 1.6 Testing Details
- 1.7 Mason Exchange
- 1.8 PNY History

2. Movie

- 2.1 See it to Believe it
- 2.2 Rising from the Rubble

3. Photo

- 3.1 Damages
 - Damage in Urban area
 - Damage in Rural areas
 - Damage in Patanka
 - Damage of Education Buildings
 - Road Damage
 - Surface Rupture
- 3.2 Rehabilitation
 - Tents and Shelters
 - Field Workshops
 - Participatory Construction
 - Shake Table Test
 - Nepal Gujarat Mason Training
 - Lives and livelihood

4. Press

- 4.1 ADPC Newsletter
- 4.2 Apparel Online
- 4.3 Economic Times
- 4.4 GSDMA Newsletter
- 4.5 PWJ Newsletter
- 4.6 World Disaster Report

Getting Started

1. Insert the PNY CD-ROM into your CD-ROM drive, then the opening page will be opened automatically.
2. If it does not work automatically, double-click "opening.html" in the "opening" folder.

System Requirements**Hardware requirements:**

- ◆ CPU: Pentium II 266 MHz or above
- ◆ Memory: 128MB RAM or above
- ◆ Display Setting:
 - Color: True color (24bit) or above
 - Screen Display: 1024 x 768

Software requirements:

- ◆ Operating System: Windows 98, ME, 2000, or XP
- ◆ Web Browser: Internet Explorer 5.5 or later
- ◆ Applications:
 - Windows Media Player 6.4 or later
 - Acrobat Reader 4.0 or later
(You can download from www.adobe.com/products/acrobat/)
 - Flash Player 6.0 or later
(You can download from www.macromedia.com/downloads/)

Patanka used to have 4-5 masons,
now we are 30.

Anjan Tarshi, Mason, Patanka

Initially we were skeptical of the fact that when
10 story houses can collapse, what about these
stone buildings? We got confidence when we learn
the construction process in the first house. We are
convinced that the earthquakes may damage our
new buildings, but it will not collapse.

Ramesh Dharsi, House-owner, Patanka

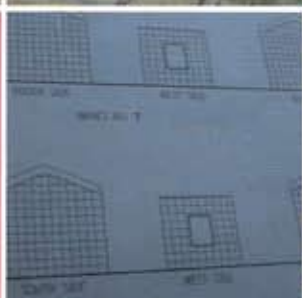
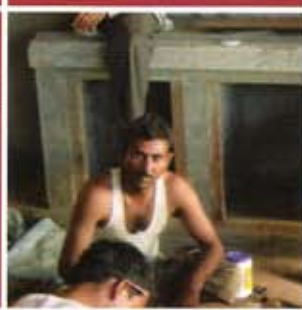

EDM
NCPDP
NGOs Kobe
NSET-Nepal
SEEDS
UNCRD

